

DS-2CE56H0T-ITZE Caméra dôme 5 MP



Caractéristiques principales

- Capteur CMOS hautes performance 5 MP
- Résolution 2560 × 1944 pixels
- Objectif motorisé à focale variable 2.7 mm à 13.5 mm
- EXIR 2.0, éclairage IR intelligent, distance IR pouvant atteindre 40 m
- OSD menu, DNR 2D, DWDR
- PoC.af
- Jusqu'au câble coaxial (HIKVISION-C)



Caméra	
Capteur d'image	Capteur d'image CMOS 5 MP
Résolution	2560 (H) × 1944 (V)
Éclairage min.	Couleur: 0.01 Lux @ (F1.2, AGC activé), 0 Lux avec IR
Durée d'obturation	PAL: 1/25 s à 1/50, 000 s NTSC: 1/30 s à 1/50, 000 s
Objectif	objectif à focale variable motorisé 2.7 mm à 13.5 mm
Champ de vision horizontal	95.7° à 29.1°
Monture d'objectif	Φ 14
Jour et nuit	Filtre anti-IR
Réglage angulaire	Panoramique: 0° à 340°; Inclinaison: 0° à 75°; Rotation: 0° à 355°
Synchronisation	Synchronisation interne
Image par seconde	PAL: 5 MP@20ips, 4 MP@25ips, 1080p@25ips NTSC: 5 MP@20ips, 4 MP@30ips, 1080p@30ips
Menu	
AGC	Prise en charge
Mode jour/nuit	Couleur/NB/AUTO
Balance des blancs	ATW/MWB
BLC	Prise en charge
DWDR (Large gamme dynamique numérique)	Prise en charge
Fonctions	Luminosité, netteté, DNR, miroir, IR intelligent
Interface	
Sortie Vidéo	Sortie Vidéo
Général	
Conditions de fonctionnement	-40 °C à 60 °C (-40 °F à 140 °F), humidité: 90% ou moins (non-condensation)
Alimentation	12 VDC ±25%, PoC.af
Consommation électrique	Max. 6.6 W
Matériau	Plastique
Portée IR	Jusqu'à 40 m
Communication	Jusqu'au câble coaxial, Protocole: HIKVISION-C (TVI sortie)
Dimensions	Ø 136 mm × 101.9 mm (Ø 5.35 × 4.01 pouces)
Poids	Environ 455 g (1.00 lb.)

Modèles disponibles

DS-2CE56H0T-ITZE

Dimensions

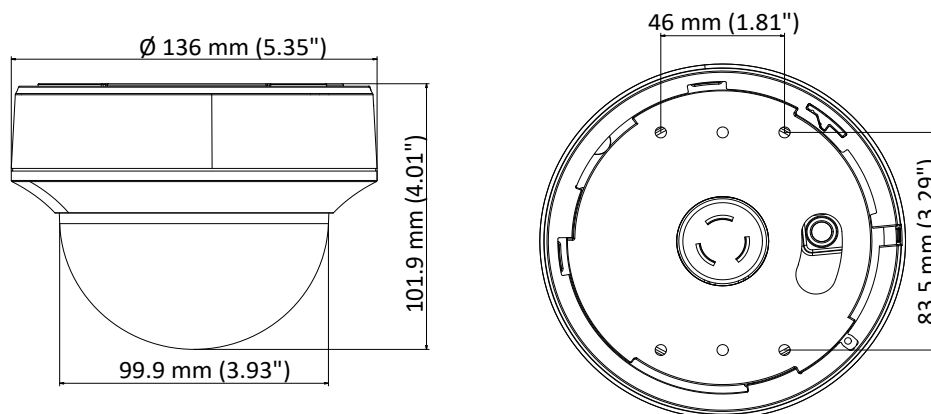

Accessoires

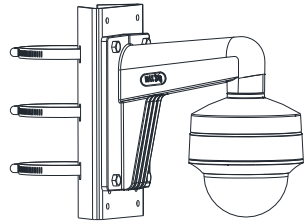

DS-1275ZJ-SUS
Montage sur poteau vertical

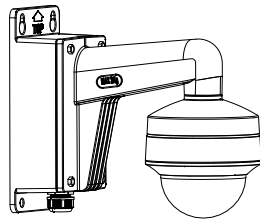

DS-1273ZJ-130B
Montage mural

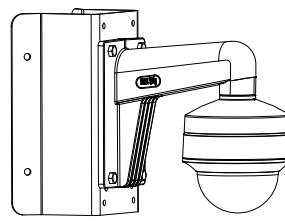

DS-1276ZJ-SUS
Montage en coin

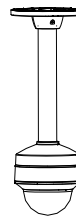

DS-1271ZJ-130
Pendantif de montage

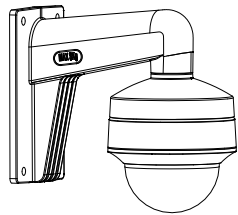

DS-1273ZJ-130
Pendantif de montage

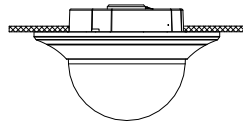

DS-1249ZJ
Montage au plafond

Distributed by



HIKVISION

Headquarters

No.555 Qianmo Road, Binjiang District,
Hangzhou 310051, China
T +86-571-8807-5998
overseasbusiness@hikvision.com

Hikvision USA
T +1-909-895-0400
sales.usa@hikvision.com

Hikvision Europe
T +31-23-55-42-770
info.eu@hikvision.com

Hikvision Middle East
T +971-4-8816086
salesme@hikvision.com

Hikvision Russia
T +7-495-669-67-99
saleru@hikvision.com

Hikvision India
T +91-22-28469900
sales@pramahikvision.com

Hikvision Italy
T +39-0438-6902
info.it@hikvision.com

Hikvision France
T +33(0)1-85-330-450
info.fr@hikvision.com

Hikvision Spain
T +34-91-737-16-55
info.es@hikvision.com

Hikvision Poland
T +48-22-460-01-50
poland@hikvision.com

Hikvision UK
T +01628-902140
support.uk@hikvision.com

Hikvision Singapore
T +65-6684-4718
sg@hikvision.com

Hikvision Oceania
T +61-2-8599-4233
salesau@hikvision.com

Hikvision Canada
T +1-909-895-0400
sales.usa@hikvision.com

Hikvision Korea
T +82-31-731-8841
sales.korea@hikvision.com

Hikvision Brazil
T +55 11 3318-0050
Latam.support@hikvision.com

Hikvision Africa
T +27 (10) 0351172
sale.africa@hikvision.com

Hikvision Hong Kong
T +852-2151-1761